

## 9 SPECIFICATIONS

Model	305FDA	3010FDA	455FDA	4510FDA	605FDA	6010FDA
Max. Seal Length	300mm	300mm	450mm	450mm	600mm	600mm
Max. Seal Thickness	2x0.5mm	2x0.5mm	2x0.5mm	2x0.5mm	2x0.5mm	2x0.5mm
Seal Width	5mm	10mm	5mm	10mm	5mm	10mm
Watts	1500w	2000w	2000w	2500w	2500w	3000w
Sealing Time	0.2-2.5sec	0.2-2.5sec	0.2-2.5sec	0.2-2.5sec	0.2-2.5sec	0.2-2.5sec
Congealing Time	1.0-8.0sec	1.0-8.0sec	1.0-8.0sec	1.0-8.0sec	1.0-8.0sec	1.0-8.0sec
Re-Cycle	1.0-8.0sec	1.0-8.0sec	1.0-8.0sec	1.0-8.0sec	1.0-8.0sec	1.0-8.0sec
Weight	21Kg	22Kg	23Kg	24Kg	25Kg	26Kg

# IMPULSE AUTOSEALER

305FDA, 455FDA, 605FDA

3010FA, 4510FDA, 6010FDA

## INSTRUCTION

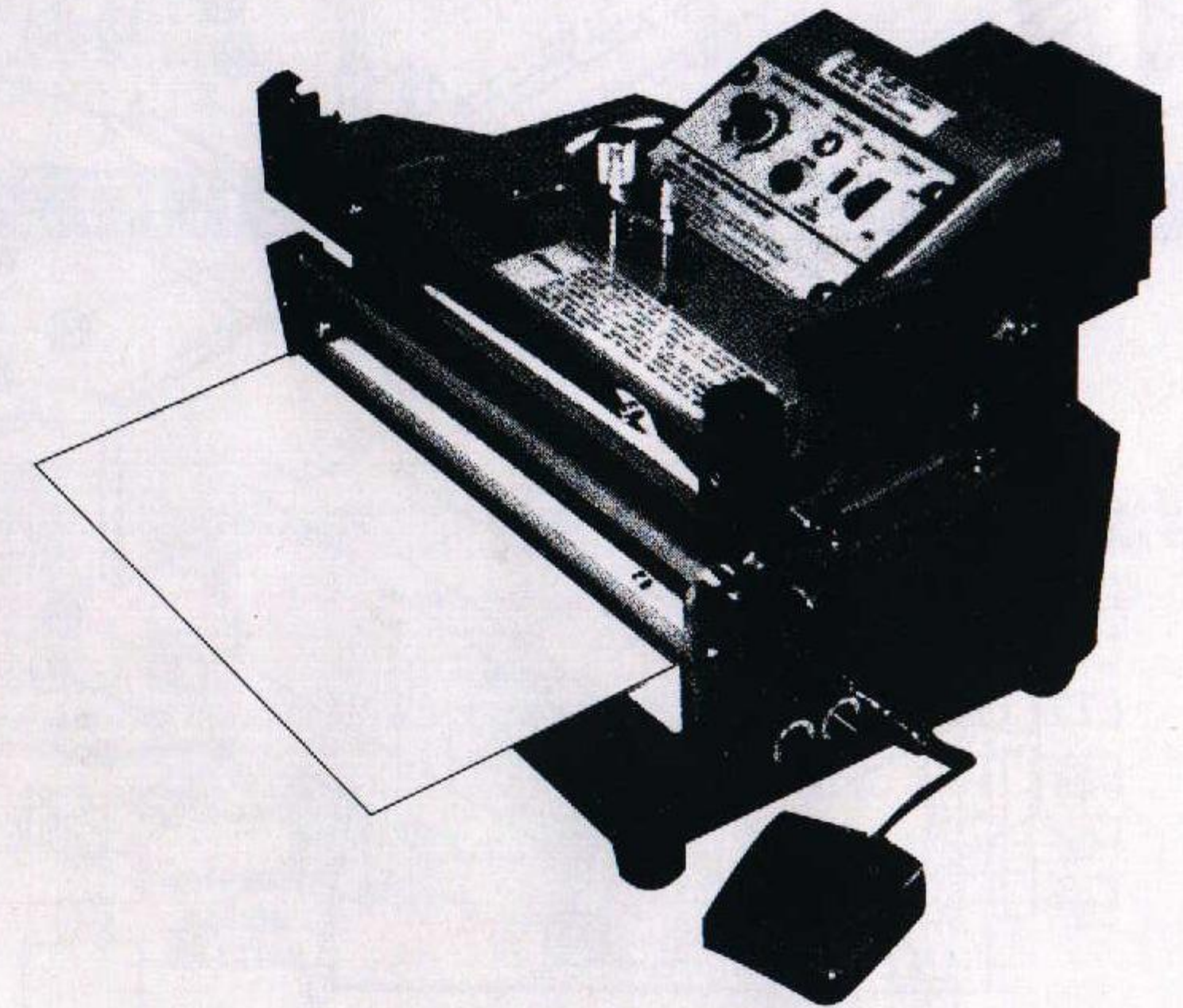

# 1 CONSTRUCTION DIAGRAM

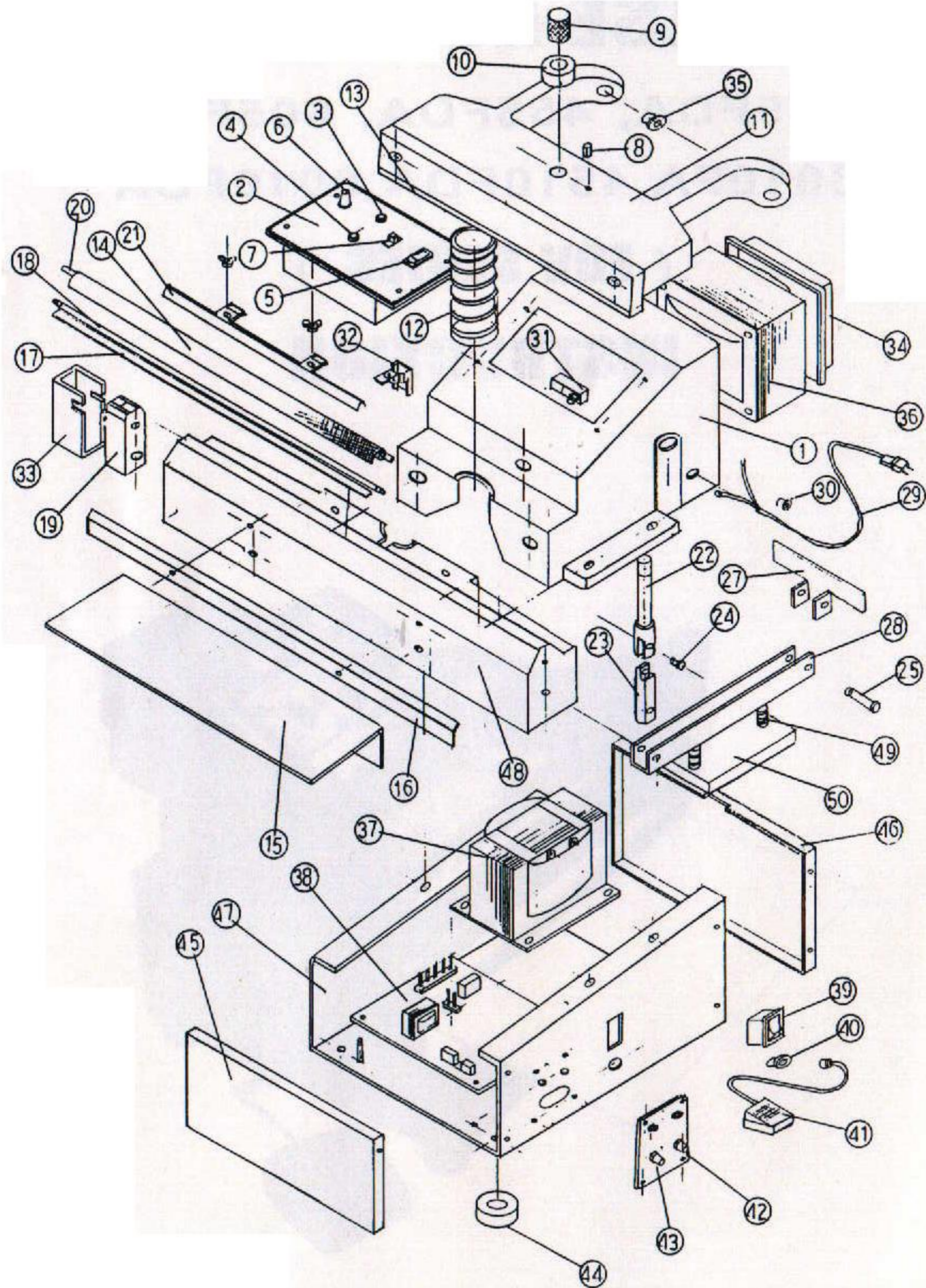

# 2 PARTS LIST

- |                               |                             |
|-------------------------------|-----------------------------|
| 1. ENCLOSURE                  | 26. RUBBER FOOT             |
| 2. TIMER CONTROL              | 27. HINGE BRACKET           |
| 3. PILOT LAMP                 | 28. UPPER JAW LEVER         |
| 4. FUSEHOLDER                 | 29. POWER SUPPLY CORD       |
| 5. POWER SWITCH               | 30. STRAIN RELIEF BUSHING   |
| 6. SEALING KNOB               | 31. LIMITED SWITCH          |
| 7. SLIDE SWITCH               | 32. INTERLOCK SET           |
| 8. SETTING BOLT NUT           | 33. END CAP                 |
| 9. UPPER LEVER NUT            | 34. TRANSFORMER COVER       |
| 10. PRESSING RUBBER           | 35. HINGE FOR UPPER JAW     |
| 11. UPPER JAW                 | 36. TRANSFORMER             |
| 12. UPPER JAW SPRING          | 37. SOLENOID                |
| 13. SILICONE RUBBER PAD       | 38. CONTROL-PCB             |
| 14. UPPER TEFLON CLOTH        | 39. ACTION SELECTOR         |
| 15. WORKING PLATE             | 40. CONNECTOR FOOT SWITCH   |
| 16. UPPER CLOTH FIX PLATE     | 41. FOOT SWITCH             |
| 17. LOWER HEATER CLOTH        | 42. CONE SEALING TIME       |
| 18. HEATER ELEMENT            | 43. RE-CYCLE TIME           |
| 19. HEATING TERMINAL ASSEMBLY | 44. RUBBER FOOT             |
| 20. METAL BAR FOR CLOTH       | 45. FRONT PLATE             |
| 21. CLIP FOR TEFLON CLOTH     | 46. BACK PLATE              |
| 22. UPPER LEVER               | 47. ENCLOSURE BASE          |
| 23. LOWER LEVER               | 48. LOWER JAW               |
| 24. HINGE SCREW               | 49. SPRING FOR MAGNET PLATE |
| 25. GROOVE PIN                | 50. MAGNET PLATE            |

# 3 CONNECTION DIAGRAM

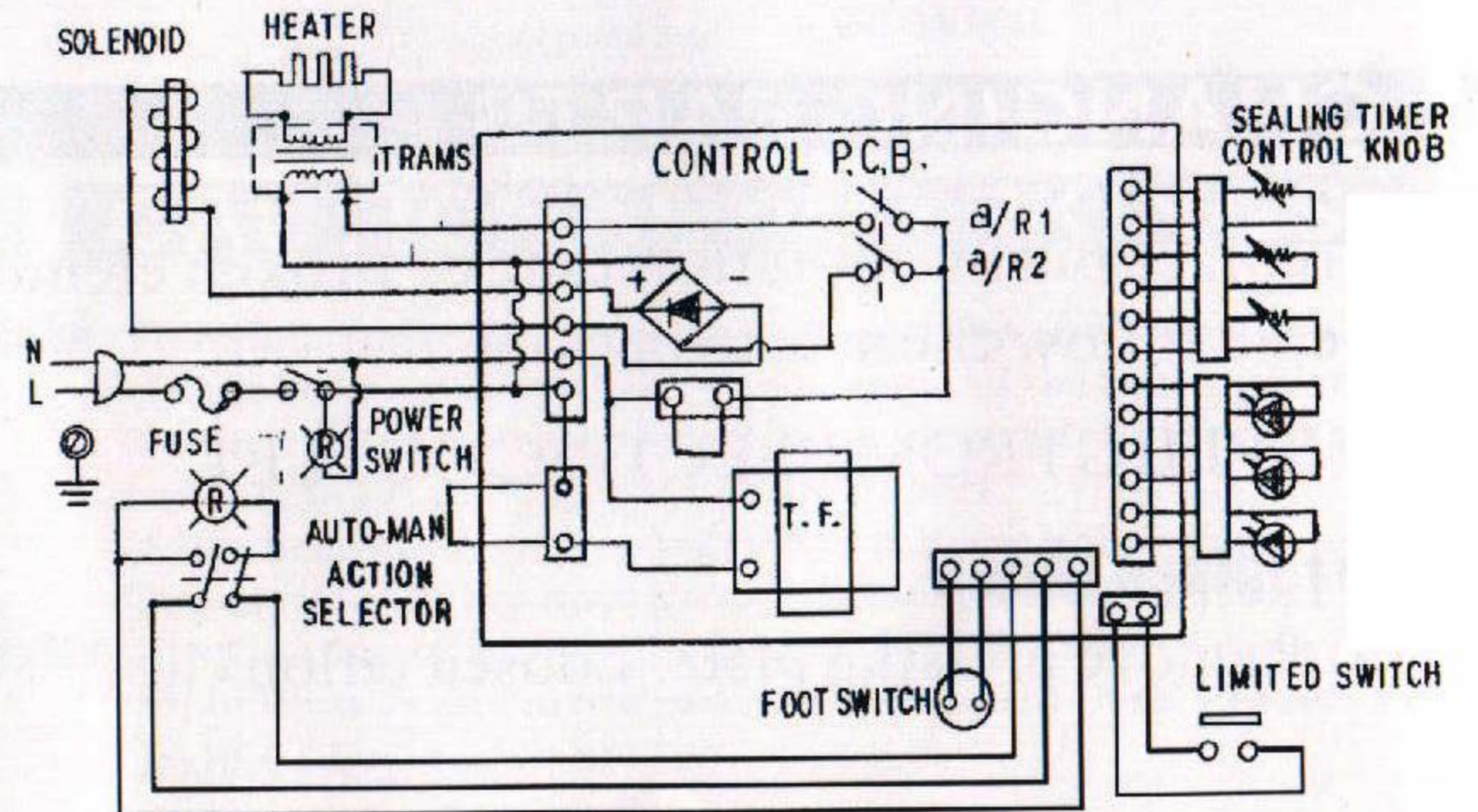

## 4 HELPFUL INFORMATION

- Always keep the sealing platform clean. Particular care 'should' be taken to remove any residue from the teflon tape.
- Do not clean the sealing platform with anything wet.
- Make sure to change the upper teflon tape (above the element wire) and the lower teflon strip (below the element wire) when they become worn. If this is not done, the element wire may short out and become damaged.
- when replacing the heating element always check the condition of the bottom teflon tape. It is important that you replace the element wire only with the one made for this machine. You can damage the transformer with the wrong element wire.
- Occasionally check the condition of the top pressure pad (silicon rubber) for wear or burn. A poor rubber pad will effect the quality of your seal.

USE ONLY GENUINE REPLACEMENT PARTS

## 5 CHANGING PARTS

To replace burnt out teflon tape or broken element wires please follow these instructions.

REMOVE PLUG FROM ELECTRIC OUTLET.

### 1. To replace Teflon

- (a) Remove pressing plate. Loosen teflon clips

- (b) Pull out teflon tape just enough to cut off burned area. Smooth out teflon and refix the pressing plate.
- (c) Rotate teflon screw to pull teflon tight. Retighten the teflon clips.

### 2. Replacing heating element wire

- (a) Loosen teflon clips. Remove pressing plate.
- (b) Lift up teflon and remove broken element wire from element locks.
- (c) Put new element wire on element locks. Do not bend or crimp the wire.
- (d) Replace teflon and pressing plate. Tighten teflon with teflon screw. Tighten teflon clips.

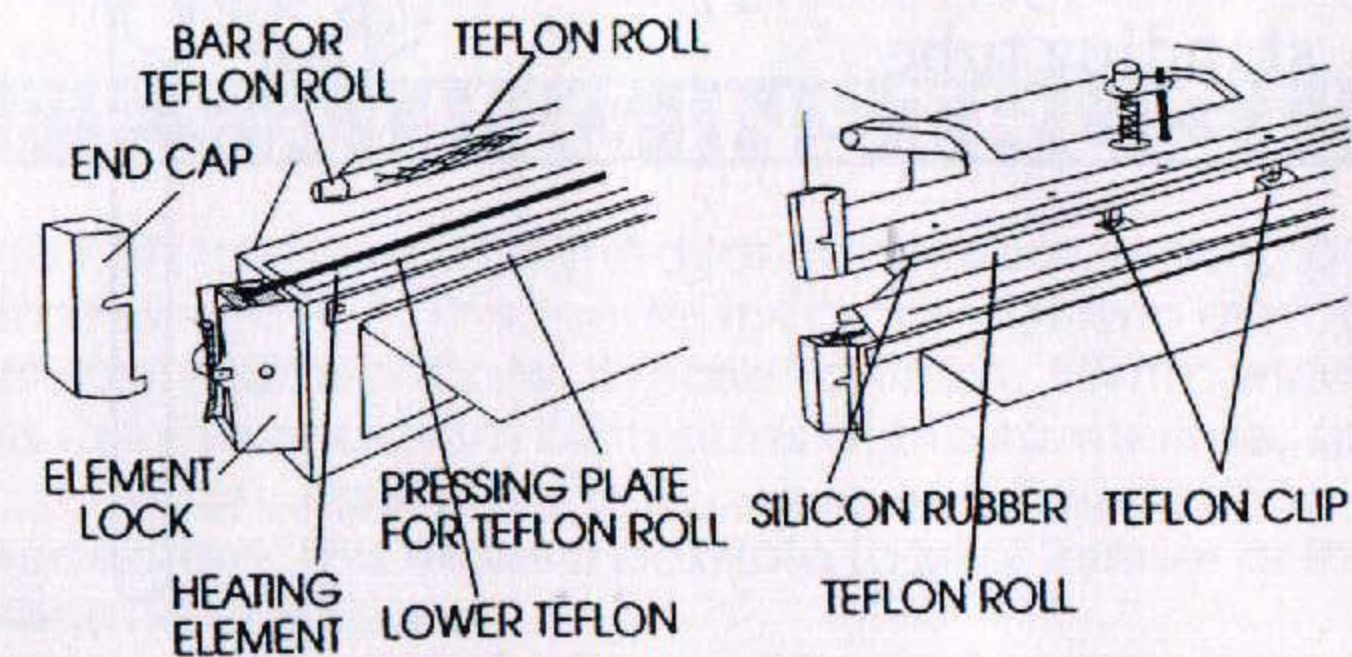

## 6 CAUTIONARY MARKINGS

- CAUTION** -To reduce the risk of shock, disconnect the unit from the supply circuit before servicing the replacement of the heating element.
- To provide continued protection against risk of electric shock, connect to properly grounded outlet only.
  - A live heating element is located in the arm under the teflon tape. Use caution during operation. **DO NOT TOUCH THE ELEMENT.**
- WARNING** -For Continued Protection Against Fire or Electric shock, Replace Only With Type Cartridge and 20A Ampere Fuse. Provided in legible adjacent to fuseholder.

## 7 ASSEMBLING FOR VERTICAL FDV SEALER

(1). Insert lower standing tube into pedal base and connect with short screws.

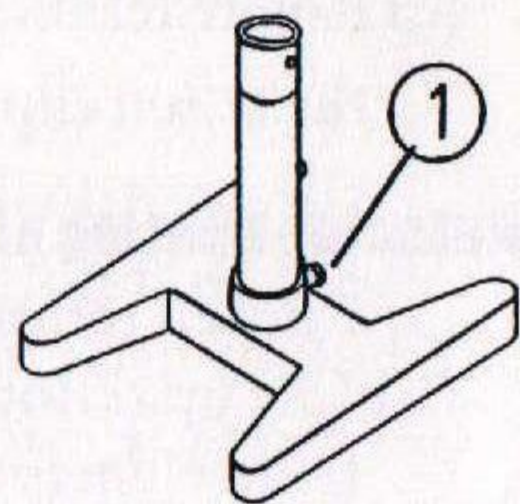

(2). With four long screws connect with body to the upper standing tube.

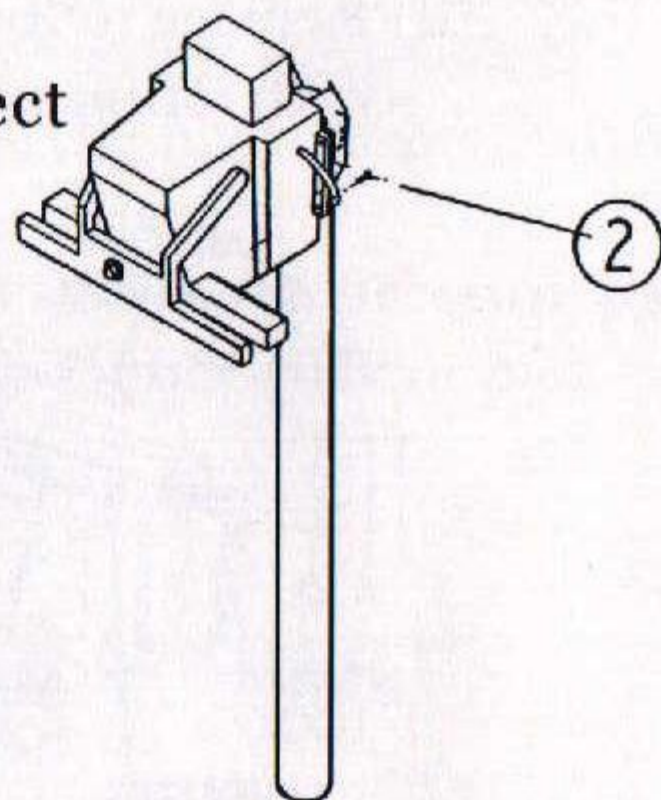

(3). Insert body upper standing tube into lower standing tube base then fitting screw.

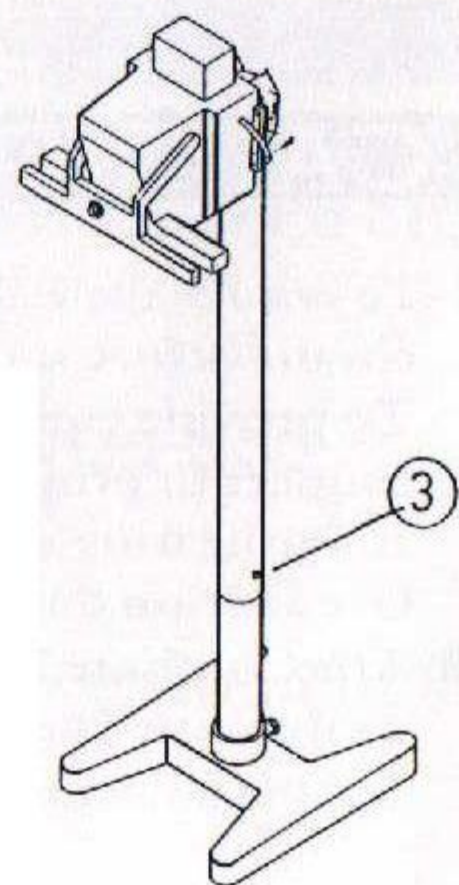

4. Fitting working plate to standing tube with four screws.

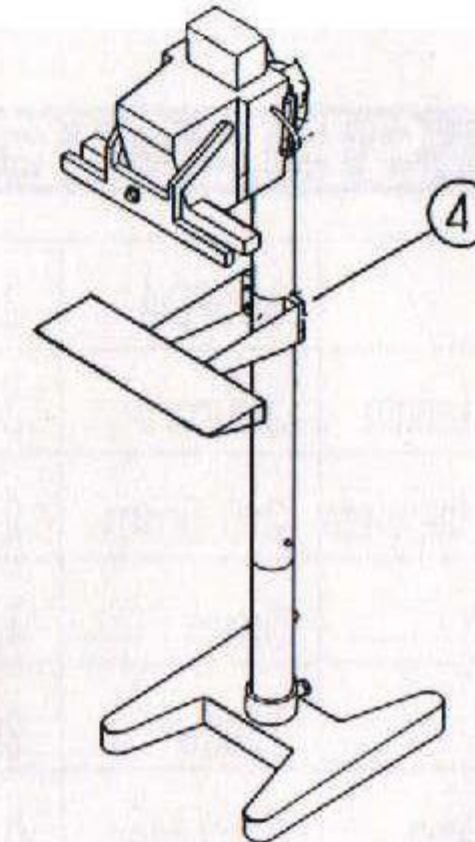

5. With two screws fitting back plate to under body then connect the foot switch.

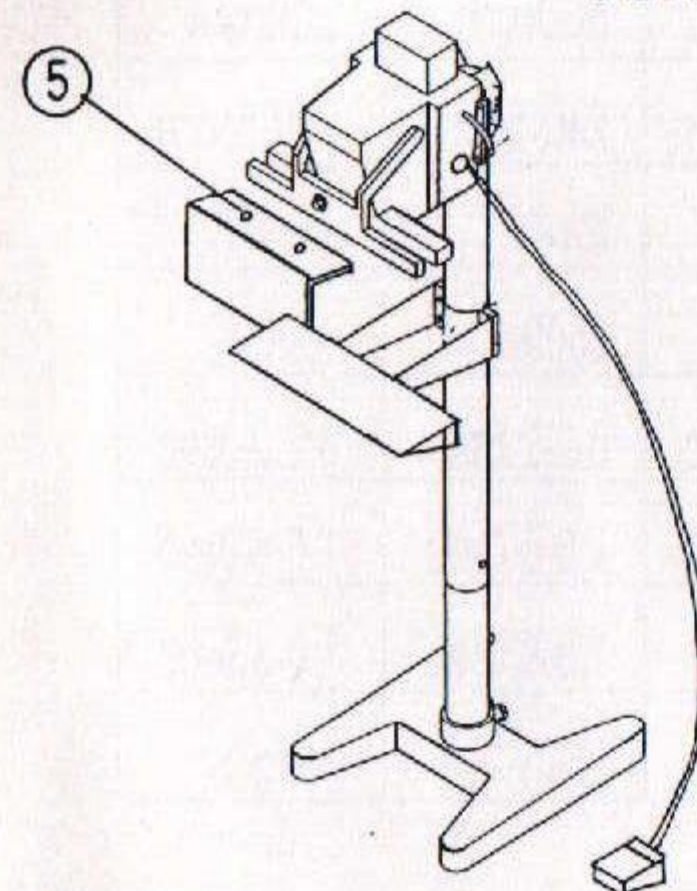

## 8 OPERATING INSTRUCTIONS

This FDA model is designed for continuous sealing of thicker thermoplastic film. This model incorporates twin elements for heavy duty applications. It makes a 5mm, 10mm wide seal and fuses the material from both sides at the same time, special slide-switch design, operator can choose one side heating or double sides heating. This make it possible to seal thinner or thicker material in one sealer.

- (1) Set power main switch to ON position.
- (2) Set selector to MAN position for manual operation by pressing the foot pedal switch, or set selector to AUTO position for automatic operation.
- (3) Adjust the re-cycle time knob, appropriate to the frequency of continuous work.
- (4) Adjust the sealing time (heating time) knob, appropriate to the thickness of plastic bag.
- (5) Adjust the congealing time (pressing time) knob, appropriate to the thickness of seal (to be cooled).

**NOTE:** Sealing and congealing time are according to the material and thickness of the plastic bags. Re-cycle time is according to the working speed of the operator.

No.	Description	Part Number	No.	Description	Part Number
1	Enclosure	*BODY-AFI	51		
2	Timer Control	*TI-FD	52		
3	Pilot Lamp		53	#22+23+24=*CA-LEVER	
4	Fuse Holder	*FUSBOXF	54	#27+28=*HINGE-CA	
5	Power Switch	*ROCKSW	55	*TI-305MC=*TI-MC	
6	Sealing Knob	*KNOB	56	#26,44=*FOOT-F	
7	Slide Switch				
8	Setting Bolt Nut	*SELT-BOLT			
9	Upper Lever Nut	*PULLER			
10	Pressing Rubber				
11	Upper Jaw	*JAW-AFI			
12	Upper Jaw Spring	*JAWSP-L			
13	Silicon Rubber Pad	*SR300FDV			
14	Upper Teflon Cloth				
15	Working Plate	*TA300FI			
16	Upper Cloth Fix Plate	*TFP400FD			
17	Lower Heater Cloth	*TFL300FDV			
18	Heater Element	*EF305FDV			
19	Heating Terminal Assembly	*CAPSETFD			
20	Metal Bar for Cloth	*TFSB300F			
21	Clip for Teflon Cloth	*CLIP300F			
22	Upper Lever Nut	*CA-LEVER			
23	Down Lever	*CA-LEVER			
24	Hinge Screw	*CA-LEVER			
25	Groove Pin				
26	Rubber Foot	*FOOT-F			
27	Hinge Bracket	*HINGE-CA			
28	Upper Jaw Lever	*HINGE-CA			
29	Power Supply Cord	*CORD-I			
30	Strain Relief Bushing				
31	Limited Switch	*MICRO-FI			
32	Interlock Set	*INTLOCK			
33	End Cap	*ENDCAPFD			
34	Transformer Cover	*TRCOVERF			
35	Hinge for Upper Jaw				
36	Transformer	*TR300FDV			
37	Solenoid	*SD600AI			
38	Control-PCB	*PCB-N2			
39	Action Selector	*SW#14			
40	Connector Foot Switch				
41	Foot Switch	*FOOTSW			
42	Congealing Time	*TI-MC			
43	Recycle Time	*TI-MC			
44	Rubber Foot				
45	Front Plate				
46	Back Plate				
47	Enclosure Base				
48	Lower Jaw				
49	Spring for Magnet Plate				
50	Magnet Plate	*FLAT			